



Powerful ■ Economical ■ Made in the USA



"I am so impressed it is unreal. The suction that thing has is amazing. The system is extremely good quality and works so well we are all finding it a little hard to believe."

- R. Mackey



Filter Flame Guard
Arrestor - U.S.
Pat. # 8,496,719

New!

SD Molded Fan Housing

- Static Dissipative
- Improved Airflow
- Noise Reduction

Lightweight yet as strong as ever!

Shown with Optional Stand

Pro 1500™ Dust Collector Quote Sheet

1.800.732.4065

www.oneida-air.com

Oneida Air Systems, Inc. was founded in 1993 to bring cost effective, state-of-the-art dust collection systems and material handling ductwork to woodworking shops. OAS designs and manufactures industrial grade dust collection systems that create a practical, safe and healthy work place environment.

The Oneida Advantage

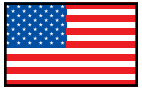

Made in the USA!

5 year Warranty

Our entire system is ETL safety certified.



Shown with Optional Angle Iron Stand.



① Motor

U.S Made Baldor Motor 3 hp, Class F TEFC Motor with a 1.15 Service Factor
Magnetic Starter with on/off switch and amperage overload protector.

② Fan Wheel / Fan Housing

Cast Aluminum Alloy 356-51, non-sparking, non-ferrous as required NFPA fire code.
No Rivets or Welds
Extremely Strong
Backward Incline design. Designed for high performance low noise.
Dynamic two-plane balanced to ISO 6.3 Specifications. (Same as aircraft turbines.)
Molded Static Dissipative Fan Housing

③ Cyclone Construction

Cyclone Technology eliminates filter maintenance.
7" welded inlet with neutral vane.
16 Gauge cyclone barrel with solid welded construction.
Powder coated paint finish over heavy gauge steel.
Outlet can be rotated independent of inlet - 8 bolt patterns

④ Filter - FCS183900

110 sq. ft. filter area.
GE Certified (H-12) HEPA Media / MERV 16+ Rated - see spec sheet on website
Filter Grounding Wire
Flame Guard Arrestor - Pat. #8,496,719

⑤ Internal Silencer

Built in Silencer reduces sound to 82 dBA @ 10'. Patented design.

⑥ Dust Drums - ODK350901

35 or 55 gallon Fiber or 55 gallon Steel available.

Bag Gripper available. Line dust drum with an easy to empty plastic bag.

⑦ Heavy Duty Wall Bracket - SMS300021

⑧ Optional Stand



HEPA Filter Media

Patented Internal Silencer
 Outlet can be rotated independent of the inlet
 Shown with Optional Angle Iron Stand.

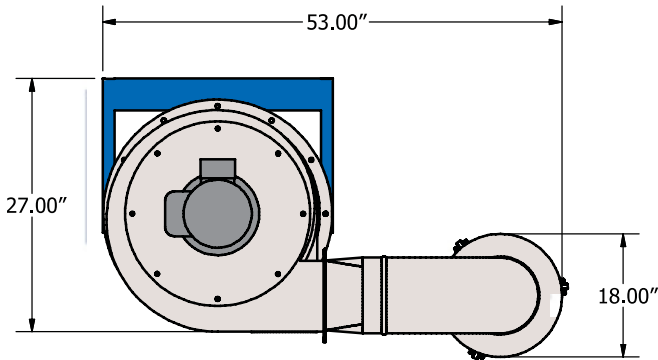

System Performance ▶ 1593 Max. CFM

System Dimensions

- ▶ Height w/ 35 Gallon Drum: 92.5"
- ▶ Footprint w/ Ext. Cartridge: 27" x 53"
- ▶ Inlet Diameter: Welded 7" w/ Neutral Vane
- ▶ Square to 7" Round included
- ▶ Outlet: Rectangle (Square to Round Adapter Available)
- ▶ Powder Coated Paint Finish Over Heavy Gauge Steel
- ▶ Weather-Proof Cyclone and Fan Blower
- ▶ Seam-Welded Construction

Integral Fan Blower
 Industrial Quality Motor

- ▶ U.S. Made Baldor
- ▶ 3 Horsepower Single Phase
- ▶ TEFC Motor, 1.15 Service Factor
- ▶ Insulation Class F
- ▶ Voltage: 1 Phase, 230V / 3 Phase. 208-230/460V
- ▶ Amperage: 1 Phase, 14.5A / 3 Phase, 8.1-7.6/3.8A
- ▶ Cast Aluminum Alloy 356-51 / Backward Inclined / Non-Sparking, Non-Ferrous as Required by NFPA Fire Code / Dynamic, Two-Plane Balanced to ISO 6.3 Specifications. The Same as Aircraft Turbine Rotors.



Filter Media

- ▶ 110 Sq. Ft.
- ▶ GE Certified (H-12) HEPA Media / MERV 16+ Rated - see spec sheet on website

Sound Level ▶ With Standard Silencer & Filter: 78 - 79 dBA @ 10'

Dust Bin ▶ 35 Gallon Fiber Drum. Other Sizes & Types Available.

Included

- ▶ Filter Efficiency Gauge
- ▶ 5 Yr. Warranty
- ▶ Patented Internal Silencer
- ▶ Magnetic Starter - w/ On-Off Switch Preset for Add-On Remote with Amperage Overload Protector (1 Phase)
- ▶ FREE D.I.Y. Duct Design Guide
- ▶ Filter Grounding Wire
- ▶ Flame Guard Arrestor - Pat. #8,496,719

Options

- ▶ Duct Design Service
- ▶ Angle Iron Stand for Free Standing Unit
- ▶ 55 Gal. Steel or Fiber Drums
- ▶ Bag Gripper, Plastic Bag Hold-Down System
- ▶ Remote Starter - Radio Frequency
- ▶ Dust Sentry™ - Infrared Bin Level Sensor Heavy Duty
- ▶ Heavy Duty One Piece Wall Bracket

System Curve

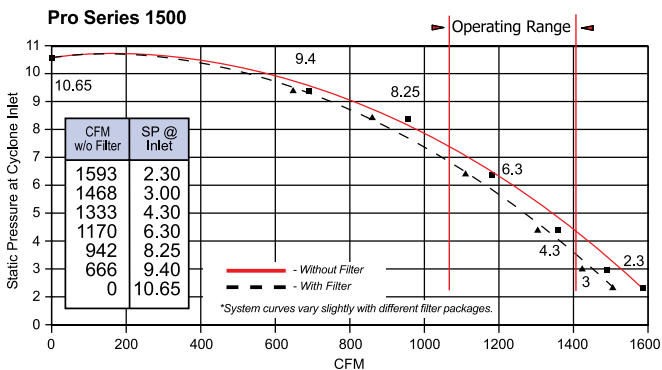

*Oneida reserves the right to change or modify specs and system appearance without notice. Actual system appearance may vary.

Oneida Pro 1500™

Part #	Description	Price
XXK150001H	3hp Pro 1500™ 1 Phase - Bundled	\$2,669.00
XXK150003H	3hp Pro 1500™ 3 Phase - Bundled	\$2,669.00
ODK350901	35 Gal. Fiber Drum	
SMS300021	Wall Bracket	

*This proposal may be withdrawn by Oneida Air Systems if not accepted within 30 days.

Let OAS help you design your dust collection system

Ductwork Design

With a system purchase and the placement of a refundable shop plan design fee, engineers and qualified technicians will size and design a custom dust collection system complete with ductwork layout including the proper pipe dimensions to run to each piece of equipment.

Trained sales technicians are available to answer questions: 1.800.732.4065

Ductwork Estimate:

Snaplock pipe & Components (24 - 26 gauge) is available with this system and costs approximately \$225 - \$250.00 per woodworking tool port. Average cost estimate for ductwork:

$$(\text{\# of Machines}) \times \$225 - \$250.00 = \text{Ductwork Estimate 24 - 26 Ga. ductwork}$$

Spiral pipe (24 Ga.) and heavy elbows are available with this system and costs approximately \$325 - \$350.00 per woodworking tool port. Average cost estimate for ductwork:

$$(\text{\# of Machines}) \times \$325 - \$350.00 = \text{Ductwork Estimate 24 Ga. spiral pipe \& heavy gauge elbows}$$

Shipping:

Snaplock shipping is free on \$300+ ductwork order / 48 states / Some restrictions apply.

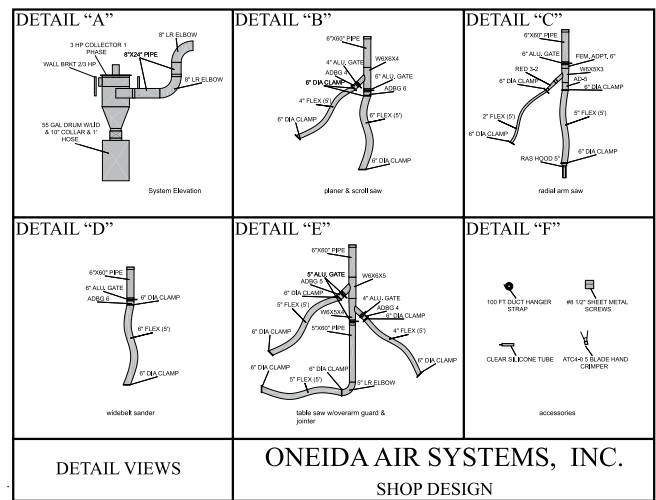
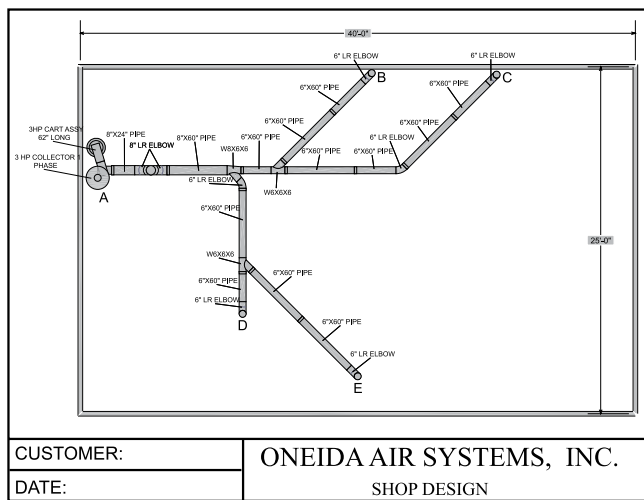

**Ready-to-Ship
Ductwork**



"Service was always great. One of the main reasons I chose Oneida was for the design service and it was all that I hoped for. I felt that the system recommended to me was exactly what my shop needed."

- R.W.

Filter and Inlet Positions

Possible Filter Positions -

Fan housing and cyclone bolt holes are drilled at 45 degree increments. Some orientations are not possible. Please check your design.

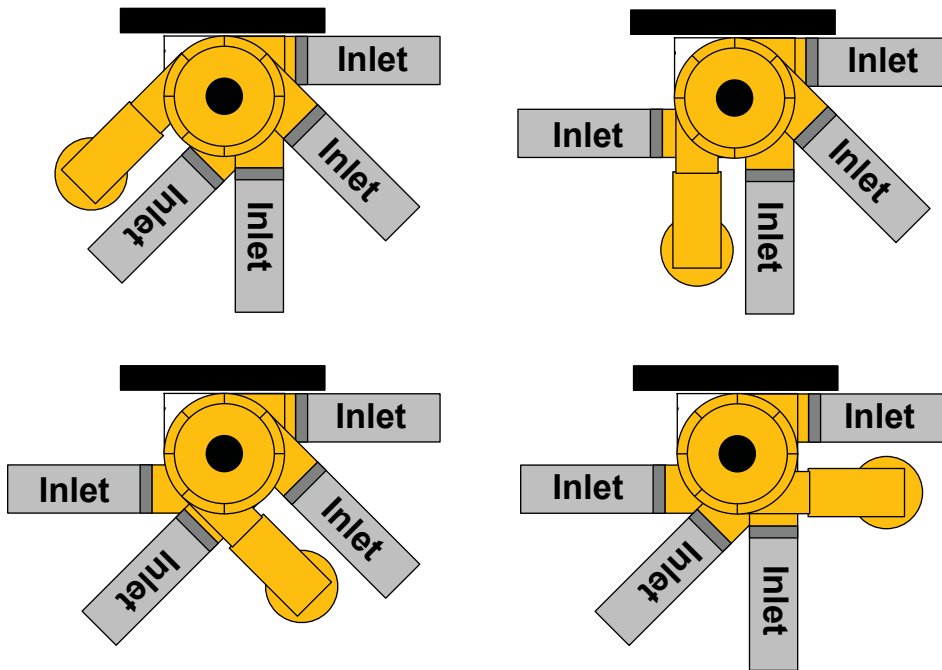

Not Possible Filter Positions -

Filter hits inlet pipe.

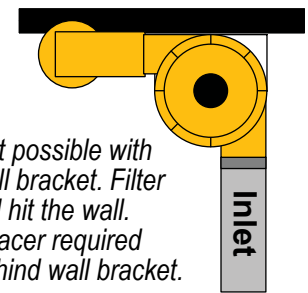
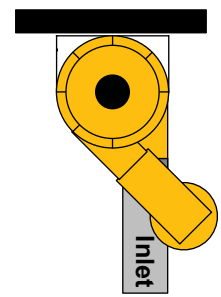

Not possible with wall bracket. Filter will hit the wall. Spacer required behind wall bracket.

Statement:

Shop plan ductwork and system drawings are drawn to appropriate dimensions and in no way should be considered exact measured drawings. Oneida Air assumes no responsibility for system dimension or configuration limitations at the time of installation. Oneida Air is not responsible for shop down time as a result of installing Oneida dust collection systems and ductwork.

General Guidelines for an Efficient Duct System

Metal Duct Gauge

Caution: Sheet metal fittings can have sharp edges.

Small custom shops do well with 22 - 26 gauge pipe fittings. Thinner gauges (such as HVAC pipe) can collapse under fan pressure or dent too easily. Shorter and more direct pipe runs are best and will deliver more air volume to the woodworking machine. Elbows and turns should be kept to a minimum. Use large radius elbows, with a center line radius at least 1.5 times the diameter.

Flex hose connections to machines can be the simplest and easiest way to connect your machines to the metal duct. Flex hose creates more air resistance than metal pipe. Use short lengths of flex hose for connecting to machines. Use wire wrapped helix flex hose for static grounding, bare the ends so they contact the metal pipe. Blast gates can be used at every machine to control air flow.

Use 45 degree wye branches, not 90 degree tee branches. A wye branch has 4x the efficiency of a tee. A 45 degree wye with a 90 degree elbow adjusted to 45 degrees will create a gentle sweep that can be used as a vertical drop or as a right or left turn off of the main duct line. Seal all ducting. Silicone makes a good sealant. Even small cracks can create significant air loss.

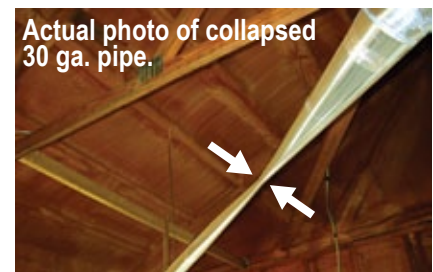

Large Radius Elbow

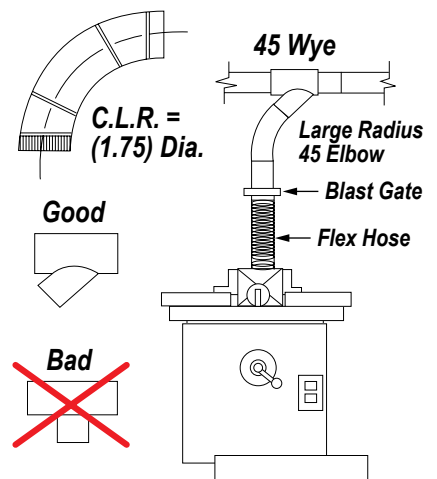

Accessories



Fiber and Steel Drums

Part #	Description	Price
SDK350901	35 Gal. Fiber Drum Kit 9"	\$85.00
SDK550901	55 Gal. Fiber Drum Kit 9"	\$99.00
SEK550901	55 Gal. Steel Drum Kit 9"	\$149.00

Kit includes Flex Hose & Hose Clamps



No line of sight required.
Radio frequency.

Remote Control Switch

Part #	Description	Price
AXR220000	Remote Control Switch	\$77.28



Heavy-Duty freestanding stand..

Stands

Part #	Description	Price
STG000035	35 Gal. Stand	\$219.00
STG000055	55 Gal. Stand	\$219.00

55 Gal. drum will not fit with 35 gal. stand.

Pat. #
8,514,090



The Oneida Dust Sentry™ with adjustable IST (Infrared Sensing Technology), flashes a strobe light to alert you when the dust in your container reaches your preset level, telling you when it's time to empty the container.

Dust Sentry™

Part #	Description	Price
AXB999110A	Dust Sentry Sensing Unit	\$148.00



Enables you to line your dust drum with a plastic bag for easy, safe dust disposal.

Drum Liner - Plastic Bag Hold-Down

Part #	Description	Price
ABX000035	35 Gal. Hold-Down	\$48.00
ABX000055	55 Gal. Hold-Down	\$58.00

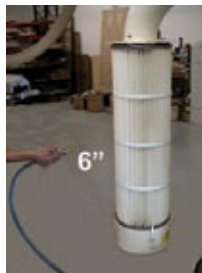

Filters are easily cleaned by blowing from the outside with compressed air.

Replacement Filters

Part #	Description	Price
FCS183900	18" x 39" Spun-Bond Filter	\$270.00
FCS183600HF	18" x 36" HEPA Media Filter	\$415.00

Spun-Bond filters 99.9% of test material from 0.2 - 2 microns.
GE Certified (H-12) HEPA Media / MERV 16+ rated
- see spec sheet on website

Universal Drum Dolly

Part #	Description	Price
SDD990000	Universal Drum Dolly	\$89.00



The Universal Drum Dolly works with all of Oneida's drums. This includes 5 / 10 / 17 / 35 / 55 gallon drums.

Stand Leg Extension

Part #	Description	Price
SXX137555	Leg Extension Kit	\$27.00



Leg extensions to use with the Universal Drum Dolly to lift your collector stand up so the drum can be easily be rolled in and out.

Items Not Covered By Quote

1. Control System: Panels, wiring, system control, breaker or starters unless noted in this quotation.
2. Freight cost, custom fees, duty or loading of freight unless noted in this quotation.
3. Federal, state, municipal or other government excise, sales, use occupational or other like taxes now in force or to be enacted unless noted in this quotation.
4. All labor required for installing the equipment.
5. Anything not specifically mentioned in this quotation.
6. Oneida Air Systems, Inc. reserves the right to void this quote in the event of a typing error or gross oversight.

WARRANTY	WARRANTY	WARRANTY	WARRANTY
90 Days	1 Year	2 Years	5 Years
Dust Deputy's Bag Gripper Remote Control Electronic Items	V - Systems Dust Cobras Mini-Gorillas	Smart Portables Gorilla Portables Super Dust Gorillas Hi-Vac Systems Direct Drive Systems Pulley Drive Systems	Pro 1500 / 2000 Smart Pro Systems* (*2 Yr. Motor Warranty)

Terms and Conditions / Shipping

Oneida tries to ship orders out in a timely manner, however sometimes delays and back orders are inevitable. Oneida will not be held responsible or liable for these conditions or the way they may effect your production. Back orders will be shipped when they are available. When orders are shipped UPS, UPS will notify you by e-mail. If shipped by Common Carrier, you can arrange for the trucking company to notify you and make arrangements for delivery. Shipping method is determined by Oneida Air Systems and is dependent upon material to be shipped and destination. You are not charged until your order is shipped.

► Checking in Order

Please look over the shipped order very carefully in the presence of the delivery person for damage or incomplete shipment before signing the delivery receipt. Please note any tears or irregularities in shipping packaging, however slight, on the shipping delivery receipt. This could be an indication of extensive concealed damage. The shipping company will not take responsibility if the damage is not noted on the delivery receipt. In the event of shipping damage, call OAS Customer Service immediately at 1.800.732.4065 so we can expedite replacements. Please check in all parts within 3 days from receiving order. Notify OAS immediately of any missing or incorrect parts. OAS does not accept any claims for damage or shortage after 3 days from date of delivery.

► Limited Warranty

Oneida Air Systems™ warrants the products manufactured by Oneida Air Systems, for a period of 1 or more years depending on the product, to the original purchaser from the date of purchase unless otherwise specified. Items not manufactured by Oneida Air Systems are limited to their own manufacturer's warranties. All electrical items such as magnetic starters, remotes, sensors, pumps and accessories are limited to 90 days. Oneida Air Systems warrants that the product will be free from defects in materials and workmanship. This warranty does not apply to defects due directly or indirectly to misuse, negligence, accidents, abuse, repairs, alterations, improper wiring or lack of maintenance. This is Oneida Air Systems sole written warranty and any and all warranties that may be implied by law, including any merchantability or fitness, for any particular purpose, are hereby limited to the duration of this written warranty. Oneida Air Systems does not warrant or represent that the merchandise complies with the provisions of any law or acts unless the manufacturer so warrants. In no event shall Oneida Air Systems' liability under this warranty exceed the purchase price paid for the product and any legal actions brought against Oneida Air Systems shall be tried in the State of New York, County of Onondaga.

ONEIDA AIR SYSTEMS SHALL IN NO EVENT BE LIABLE FOR DEATH, INJURIES TO PERSONS OR PROPERTY OR FOR INCIDENTAL, AND CONTINGENT, SPECIAL, OR CONSEQUENTIAL DAMAGES ARISING FROM THE USE OF OUR PRODUCT.

► Safety Warning - Please Read

Before Purchasing or Installing a dust collection system the buyer is cautioned to do so in accordance with prescribed Federal, State, Local, OSHA, NFPA, and any other applicable codes or regulations relating to the type of dust(s) you are collecting.

SOME TYPES OF DUST UNDER CERTAIN CONDITIONS HAVE THE POTENTIAL TO BE EXPLOSIVE.

Oneida Air Systems is not responsible for how the dust collector is used or installed. Dusts with deflagration or explosion risks, such as wood dust, may require additional safety equipment including but not limited to; venting, spark detection, suppression systems, back draft dampers or may require installation in an outside location or in a protected area away from personnel. The customer assumes the responsibility for contacting their insurance underwriter with regard to specific engineering controls or application requirements. (We suggest you reference NFPA 664, 654 and 68 codes for more information) Oneida Air Dust Collection Systems may not be suitable for some applications and are not designed to be used in explosive atmospheres. **Oneida Air Systems equipment should only be installed and wired by a licensed electrician following all applicable local and national electrical codes.**

Some dust created by power sanding, sawing, grinding, drilling, and other construction activities contains chemicals known to cause cancer, birth defects or other reproductive harm. Some examples of these chemicals are:

- Lead from lead-based paints.
- Crystalline silica from bricks, cement and other masonry products.
- Arsenic and chromium from chemically-treated lumber.

Your risk from these exposures varies, depending on how often you do this type of work. To reduce your exposure to these chemicals, work in a well ventilated area, and work with approved safety equipment, such as those dust masks that are specially designed to filter out microscopic particles. Oneida Air Systems recommends using additional approved safety equipment such as an approved OSHA and NIOSH dust mask or respirator.

Oneida Air Systems makes every effort to accurately represent our products, specifications and prices; however Oneida Air Systems reserves the right to make changes to products and prices at any time. As a manufacturer, Oneida Air Systems reserves the right to change product designs and specifications at any time.

► Delivery Risk of Loss

Products will be shipped to Buyer's single destination. Title and risk of loss shall pass to the Buyer upon delivery to such destination. Buyer pays transportation expenses. Dates of shipment are advisory and Oneida Air Systems will make reasonable efforts to ship on or before the date states for shipment, however, Oneida Air Systems shall not incur any liability for failure to ship on that date.

► Returned Goods Policy

Buyer must inform Oneida Air Systems of any shortage or damage, by so noting in writing, on the freight delivery bill prior to signing to indicate receipt of shipment. All claims covered under the limited warranty, are subject to inspection and investigation by Oneida Air Systems. Oneida Air Systems reserves the right to inspect and investigate all returned products before Buyer's claim is settled. All products returned for a refund must be unused and resalable and purchased within the last 30 days. There are no refunds on flex hose or custom made components. There will be a 25% restocking fee applied to any returned items. Buyer must call and obtain a Return Material Authorization Number (RMA #) prior to making a return. All merchandise must be shipped to us prepaid.