

- Self-contained sensor head “*Infraducer*®” with analog 4-20mA linear and digital RS485 outputs
- Through-lens sighting
- Variable focussing
- 0.5% accuracy
- Fast response of 7.5 ms
- Fiber optic version for harsh environments
- 4 digit alpha numeric display
- Remote configuration software
- Single 24V power supply

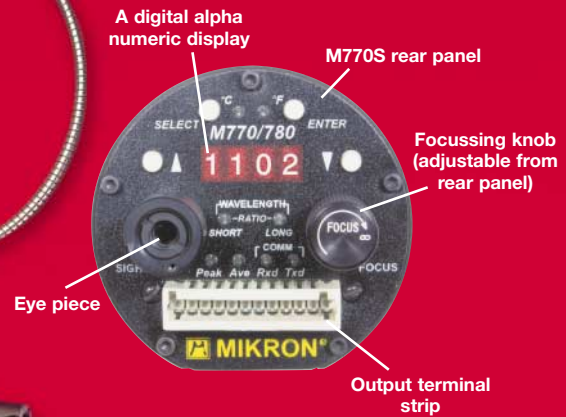

**Model M780 Fiber Optic Version**  
for Harsh Environments



**Model M770/770S**  
through-lens sighting (M770S)

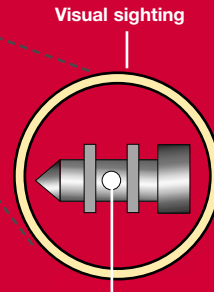

“Infraducer” is a registered trademark of Mikron Instrument Co.

Visit [www.mikroninst.com](http://www.mikroninst.com)

# M770/780 2-color Infrared Temperature Transmitters

## Innovative Design

Mikron M770/780 "Infraducers" series represent another milestone in innovative infrared thermometry. Designed by integrating advanced non-parallax optical sighting with a fully digital electronics system in a single package providing unparalleled accuracy and speed for demanding industrial and scientific applications. A built-in 4-digit alpha numeric display located on the rear panel displays temperature and menu for selection of instrument initial settings. The linear analog 4-20mA and RS485 digital outputs provide the convenience of long distance signal transmission for temperature measurement, control and data collection. The M770/780s' unmatched array of protective accessories, demonstrate Mikron's commitment to long-term trouble-free operation of these instruments.

## Universal Application

The M770/780 "Infraducers" series has the ability to measure the temperature simultaneously in three different ways. This insures that all laws of radiation physics are observed for accurate measurements. If there is any inconsistency between readings, the smart microprocessor algorithm identifies the source of the discrepancy on the rear display for user's immediate correction. The RS485 output when connected to a PC allows correction of parameters remotely.

## Why 2-color Infrared Thermometry?

M770/M780 "Infraducers" series also utilizes the 2-color principle, in which the temperature measurement is made by two independent detectors with different but adjacent narrow band infrared filters. By ratioing the output of these two detectors, the temperature measurement becomes independent of emissivity and a number of other factors that during the measurement degrade the accuracy of conventional instruments. Thus, temperature measurement with the M770/780 are:

- Unaffected by emissivity change for gray targets
- Unaffected by dust and other contaminants in the field of view
- Unaffected by varying target size (provides accurate reading with only 5% of target area within field of view)
- Unaffected by dirty viewing window
- Unaffected by small oscillating target within field of view

## Model M770S

The M770S is housed in a compact, rugged, anodized aluminum housing about 200mm (8") long. This self-contained sensor head incorporates a high quality, high resolution variable focus optical system that provides a sharp erect image of the target. Focussing is executed by turning the focusing knob on the rear panel of the instrument.

The M770S enables precision pinpointing of small target areas. The user simply adjusts the instrument until the desired target is clear within the reticle. (See front cover).

## Model M770

The M770 is identical to the M770S except it has no through-lens sighting and focusing is factory fixed for a pre-determined distance. This unit is only desirable for application where target is sufficiently large and pin pointing of measurement spot is not important.

## M780 for Inaccessible or Environmentally Severe Applications

The fiber optics based M780 "Infraducer" is recommended for areas where the following conditions exist:

- A. When direct sighting with the M770S is impossible due to obstructions. The flexibility of the fiber optics cable overcomes this problem.
- B. Where RF or EMI interference is a problem, requiring the electronics to be placed at a safe distance from the source of interference.
- C. Where exceptionally high ambient temperatures exist. Fiber optic tips and lens assemblies can withstand temperatures up to 600°F (315°C) without cooling and up to 1000°F (540°C) with air cooling.
- D. Where corrosive environments prohibit the use of a conventional system.
- E. In vacuum applications where sighting through the window is difficult or impossible, a fiber optics lens assembly can be placed inside the vacuum vessel, using Mikron's exclusive fiber optic feed-through bushing.
- F. When a non-electrical fiber optic version allows installation in hazardous locations.

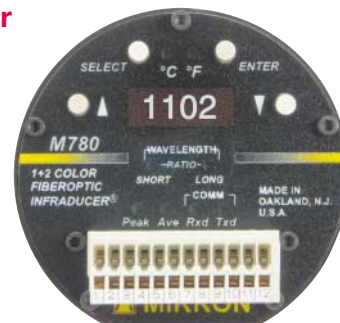

M780 rear panel

## Application Assistance

Many years of experience in solving unusual and difficult infrared temperature measurement problems qualifies our sales and application engineering staffs to offer solutions to the most challenging applications encountered in industry and science.

## Quality Assurance

Reliability is never taken for granted at Mikron. Before final calibration, every "Infraducer" is tested and burned-in, rigorously subjected to a period of thermal cycling and vibration to insure the integrity of the instrument.

Mikron maintains ISO 9001 certification with Factory Mutual with auditing interval of every 6 months.



Aluminum housing to protect optics and electronics

# Typical Applications

The unique features of models M770/780 "Infraducers" makes this series ideal for a wide range of temperature measurement applications above 300°C (540°F). These include metal melting,

heat treating, ore smelting, wire and rod forming, induction heating, vacuum furnaces, utility furnaces, glass furnaces, rotating kilns, crystal growing and RTP in the semiconductor industry.

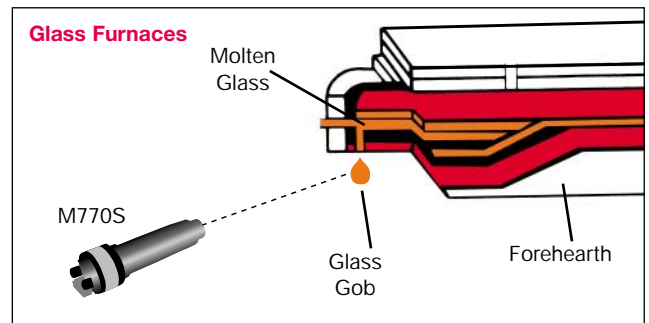
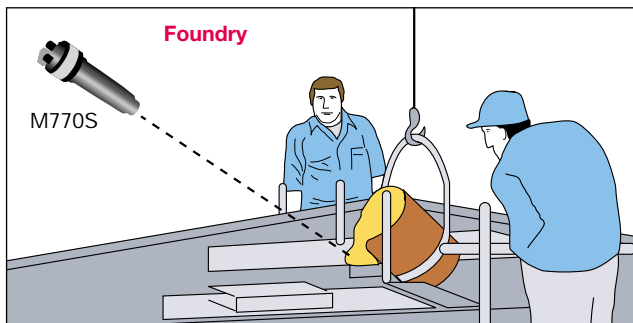
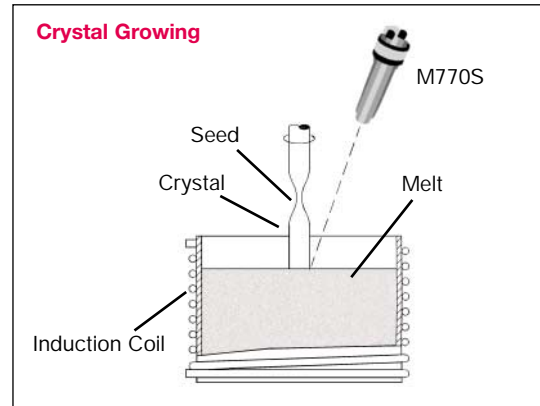
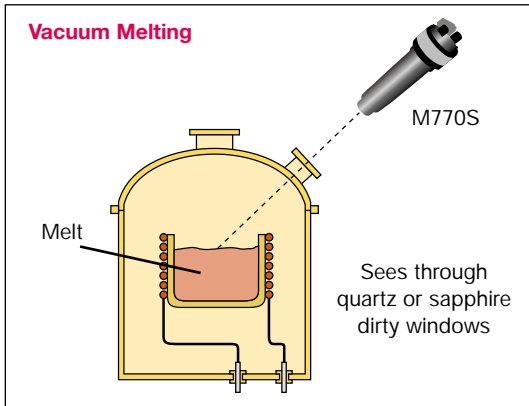

## M780 "Infraducer" Fiber Optic Version

The use of fiber optic infrared thermometers for measurement and control of automatic induction heating systems is well

established. Further advantages of the M780 lie in its ability to accurately measure shiny surfaces.

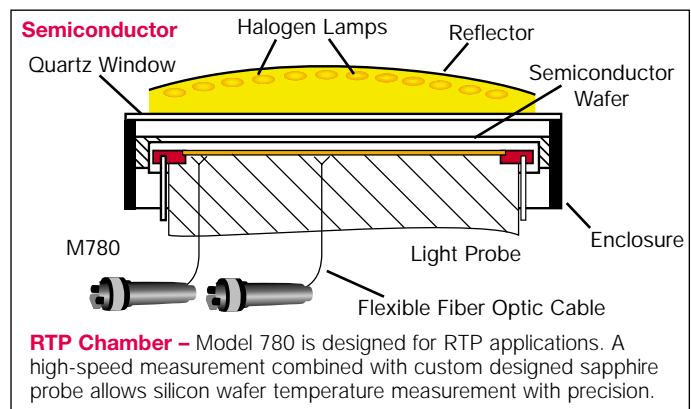
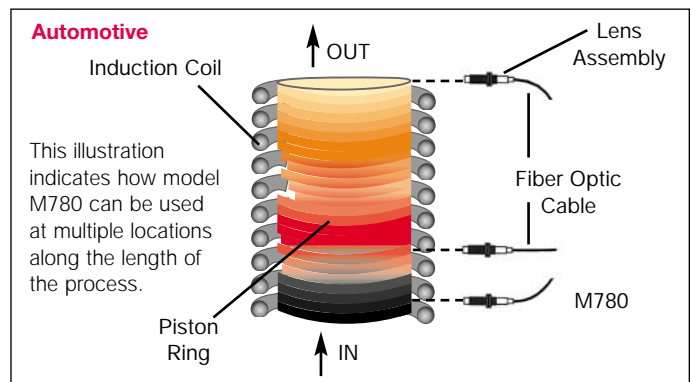
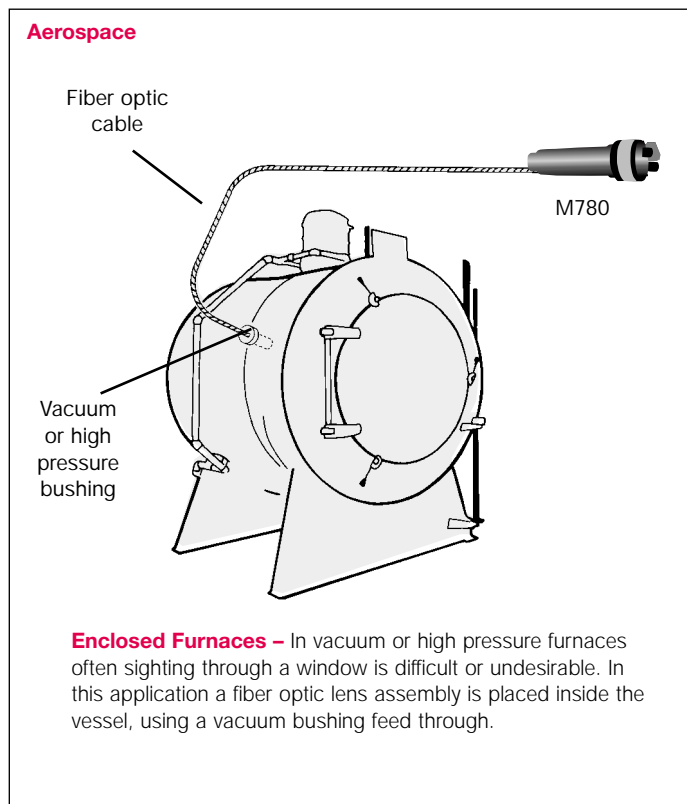

# How to Select an M770 or M770S "Infraducer"

## Selection Procedure:

- a. M770 – Fixed focus (no sighting)
- b. M770S – Variable focus, see through-lens sighting

After choosing the desired model follow these 4 steps.

1. Select the temperature range and units (C or F) from ranges listed. Insert ranges and units in Box **1**, filling in all blanks with zeros.
2. Place letter "R" or "R1" in Box **2** for standard spectral response.
3. Select signal output; (L) for standard 4-20mA linear and RS485 and insert in Box **3**.
4. Select the correct operating distance.
  - a. If you selected the M770 fixed focus model, specify the desired focus distance in writing (See Table 1 and optical resolution box below) and enter "U" in Box **4**.
  - b. If you selected the focusable M770S read the section "Optical Resolution" below. Then choose the desired operating distance and insert the corresponding Code No. in Box **4**.

## Example

The model chosen for the instrument indicated in the selection chart is the focusable M770S with through-lens sighting for a temperature range of 750° to 2000°C, standard spectral response of two narrow bands, analog 4-20mA linear and digital RS485 outputs and a focusable operating distance of 380mm (15") to infinity with field of view ratio of 90:1.

## Selection Chart

°C or F

M770S — [ 0 7 5 0 - 2 0 0 0 ] [ C ] — [ R ] — [ L ] — [ 1 ]

[ 1 ]                      [ 2 ]                      [ 3 ]                      [ 4 ]

Temperature Range (see note 1)		Field of View Ratio	Spectral Response		Output		Operating Distance (see note 2)	
°C	°F		CODE	CODE	CODE	CODE		
300-850*	572-1562*	60:1	TWO NARROW BANDS	R1	Analog 4-20mA	L	380mm (15") to infinity	1
450-1200*	850-2200*	60:1	NEAR INFRARED	R	Linear and Digital RS485		150mm (6") to 380mm (15")	2
600-1400	1100-2550	60:1						
750-2000	1400-3600	90:1						
1000-3000	1800-5400	180:1					50mm (2") fixed	3

Notes: 1. Special temperature ranges are available upon request.  
2. See table 1 for availability of standard fixed focus distances for a given FOV ratio.

**Table 1 – M770 Fixed Focus Distance**

Field of View Ratio	Standard Fixed Focus Distance	Minimum Focus Distance
30:1	0.75m (30")	50mm (2")
60:1	1.5m (60")	150mm (6")
90:1	2.1m (90")	150mm (6")
180:1	4.5m (180")	380mm (15")

**Table 2 – M770S**

Minimum target sizes are shown in the table below

Field of View Ratio	Version 1 Focus 15" to Infinity	Version 2 Focus 6" to 15"	Version 3 Focus at 50mm (2")
60:1	6mm (0.24") at 380mm (15")	2.5mm (0.10") at 150mm (6")	0.8mm (0.03") at 50mm (2")
90:1	4mm (0.16") at 380mm (15")	1.8mm (0.07") at 150mm (6")	N/A
180:1	2.1mm (0.1") at 380mm (15")	0.8mm (0.03") at 150mm (6")	N/A

## Optical Resolution Model M770S

Three different lenses are available for the M770S. The one you should choose depends on the desired working distance of the unit. The first version is designed to measure temperature at distances of 380mm (15") to infinity. The second version has a working range of 150mm (6") to 380mm (15"). The third version is fixed to measure temperatures at a 50mm (2") distance. Proper focussing is achieved by mounting the unit at the desired distance and adjusting the focussing knob on the rear panel of the instrument until the target comes into clear view in the reticle. When the target is in focus to the eye, it is also in focus to the detector. Reticle defines exact size and position of measurement spot.

### Model M770

Exact Target Diameter determined by the formula:

$$\text{Target Diameter (d)} = \frac{\text{Focussed Distance (D)}}{\text{Field of View Ratio}}$$

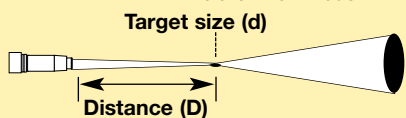

Example: M770, distance with 60:1 FOV ratio focussed at 380mm (15") distance

$$\text{Minimum Target Size(d)} = \frac{D}{\text{FOV ratio}} = \frac{380}{60} = 6.4\text{mm}$$

(or  $\frac{15"}{60} = 0.25"$ )

## How to Select an M780 "Infraducer"

The selection process for the M780 is similar to that of the M770, with the additional requirements of the fiber optic feature. The selection steps are as follows:

1. Select the temperature range and units (C or F) from ranges listed. Insert ranges and units in Box **1**, filling in all blanks with zeros.
2. Place letter "R" or "R1" in Box **2** for standard spectral response.
3. Select signal output; (L) for standard 4-20mA linear and RS485 and insert in Box **3**.
4. Select the length of fiber optics cable and insert code number in Box **4**.
5. Select the required lens assembly from the field of view diagrams and insert code number in Box **5**.

# How To Select An M780 "Infraducer"

## Selection Chart

°C or F

M780 — 0 7 5 0 — 2 0 0 0 C — R — L / S 1 2 / 0 6 0 S

Temperature Range (see note 1)		Field of View Ratio	Max. Fiber Optic Length	Spectral Response		Output	Fiber Optic Cable			Standard Focus Lens Assembly (see note 2)			
°C	°F			CODE		CODE	Length cm	Fl.	CODE	FOV	FOCUS	CODE	
450-1200*	850-2400*	30:1	360cm (12')	TWO NARROW BANDS NEAR INFRARED	R1	Analog 4-20mA Linear and digital RS485	90	3	S03	30:1	30"	030S	
600-1400	1100-2550	30:1	900cm (30')		180		6	S06					
750-2000	1400-3600	60:1	900cm ( 30')		R		L	360	12	S12	60:1	60"	060S
1000-3000	1800-5400	90:1	900cm ( 30')		540			18	S18				
							720	24	S24				
							900	30	S30				
							Special Length - (consult Mikron)		SXX	90:1	90"	090S	

## Standard Focus Distance

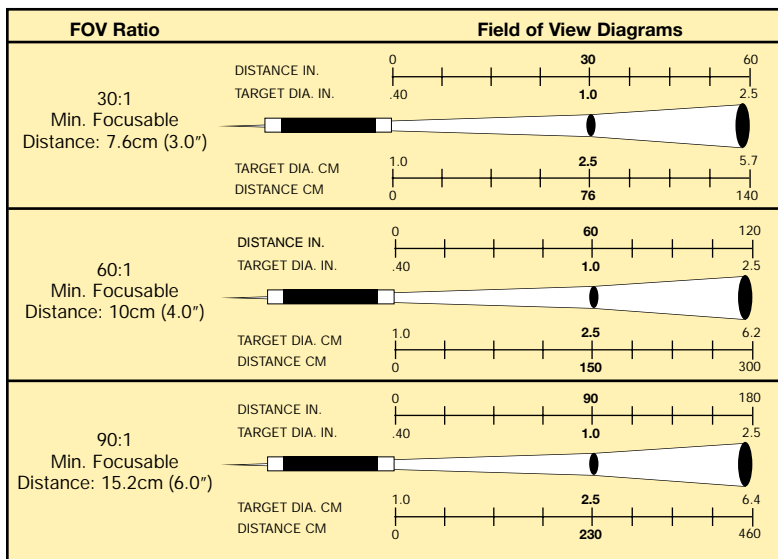

## Example

The model number for the M780 "Infraducer" indicated in the boxes designates a sensor with a temperature range of 750° to 2000°C with an analog 4-20mA linear and digital RS485 outputs using 360cm (12') length of fiber optics cable, a standard lens assembly with a field of view ratio of 60:1 at standard focus distance of 1500mm (60").

- Notes: 1. Special ranges are available upon request.  
2. For non-standard focus distance see explanation in chart below.

## Non-Standard Focus Distance

When non-standard focus distance is desired, such as close focus, insert code "U" instead of "S" as the last digit in the model number specify focus distance in writing. Minimum target diameter is determined by the formula.

$$\text{Minimum Target diameter (d)} = \frac{\text{Focussed Distance (D)}}{\text{Field of View Ratio}}$$

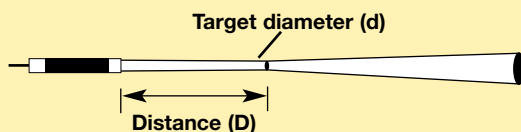

Example: Min. target diameter for focus distance of 30cm (12") and FOV ratio of 90:1, is

$$\text{Minimum Target diameter} = \frac{30}{90} = 0.33\text{cm or } \frac{12}{90} = (0.13")$$

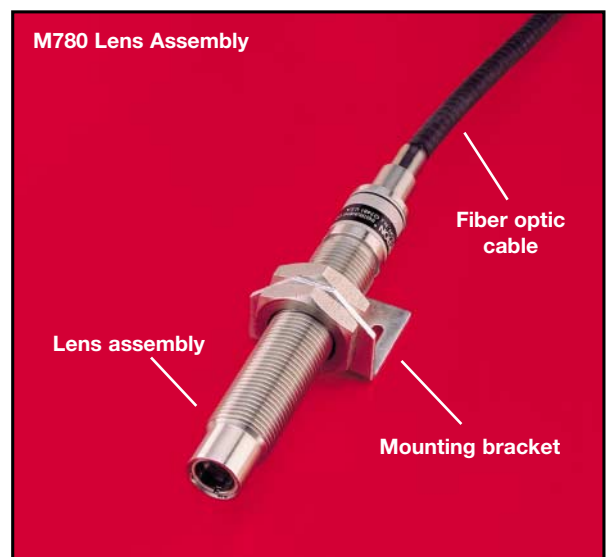

# Specifications

## M770/770S/780 Specifications

**Accuracy:**  $\pm 0.5\%$  of full scale, (1% for ranges marked \*)

**Repeatability:** 0.1% of full scale span

**Temperature Resolution:** 1 °C/°F

**Spectral Response:** One or two narrow bands near infrared region

**Sighting Methods:** Through the lens sighting (M770S only)

**Working Distance:** 15" to inf. (38cm to inf.)

**Close Focus Option:** 6" to 15" or fixed at 2" (50mm)

**Temperature Display:** Bright alpha numeric LED, 4 digits  
17.5mm (L) x 6mm (H) (0.7" x 0.25")

**Temperature Mode:** Current temperature, average temperature (up to 100 reading average), Peak with auto reset

**Speed of Response:** 7.5 milliseconds for 95% of final reading. Adjustable to 1 second

**Slope:** Adjustable from 0.800 to 1.200 in 0.001 steps

**Emissivity:** Adjustable from 0.10 to 1.00 in 0.001 steps

**Menu Selection:** By rear panel push buttons °C/°F, High/Low

alarm, Average, Peak, Slope, Emissivity, Transmission Loss, Temperature span, Rate of temperature change, Peak and Hold, Speed of response and Internal instrument temperature

**Analog Output:** 4-20mA (500 $\Omega$  max load) isolated and scaleable

**Digital Output:** Bi-directional RS485 communications (networkable)

**Relay:** Programmable Relay Output, Type C Contacts

**Power Source:** 19 to 35 V DC at 150 mA Typical

**Ambient Temperature:**

Operating: 0° to 50°C (32° to 122°F)

With cooling jacket: up to 200°C (32° to 392°F)

Storage: -40° to 80°C

**Housing Material:** Hard anodized aluminum

**Housing:** NEMA 4 (IP 65 IEC529) (with Protective Jacket)

**Dimensions:** 178mm x 60mm (7" x 2.4")

**Weight:** 0.46kg (1 lb.)

## M770/770S Housing Dimensions

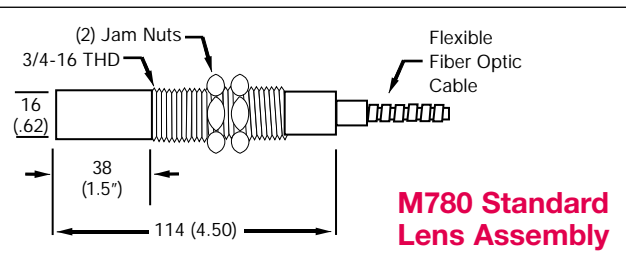
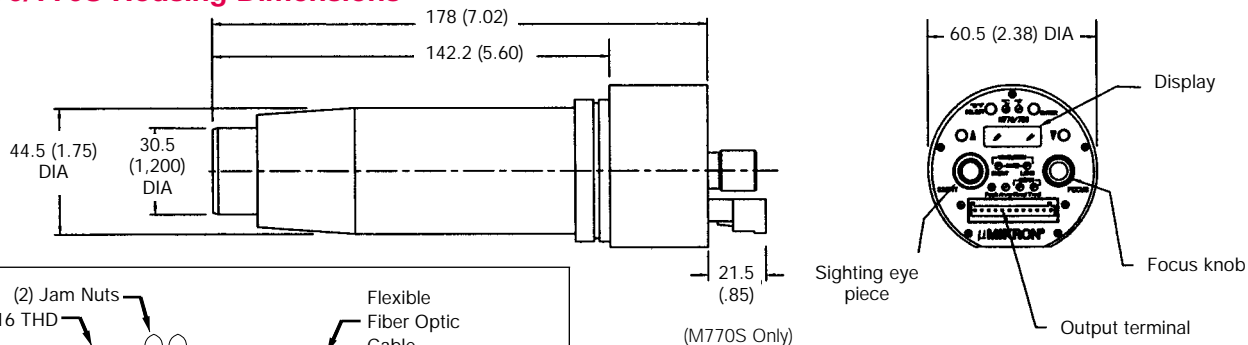

Note: M780 electronics is placed in same housing as M770. See above for details. Dimensions are mm (inch)

## Additional Specifications for M780 Only

**Lens Assembly Material:** All lens assemblies are machined from solid stainless steel material.

**Lens Mounting:** All mounting brackets and necessary hardware are supplied by Mikron.

**Fiber Optic Cable Material:** Glass fibers in bundle form protected by flexible stainless steel sheath. Min. bend radius 50mm (2").

**Operating Ambient Temperature:**

a. Lens assembly: -60° to 315°C (-75° to 600°F)  
Lens with cooling jacket: up to 500°C (930°F)

b. Fiber optic cable: stainless steel: -60° to 200°C (-75° to 392°F)

**Relative Humidity:** 90% (non-condensing)

**Vibration:** 3g's any axis continuous

**Shock:** 50g's

## Communication Software

Optionally available is Mirdac software designed for M770/780 "Infraducers" series by using the standard RS485 output for performing remote configuration settings, data collection and recording. Remote setting includes: Slope, Emissivity, Degrees C/F, Speed of response, Temperature span, High/low alarms, Peak and Hold, Rate of temperature change, Transmission Loss, Internal instrument temperature and Calibration adjustments. In addition the software allows:

- Log data to disk in ASCII format with variable speed exportable to Excel, Lotus and Word
- Graph of temperature versus time

## NIST Traceable Calibration Certificate

Mikron infrared thermometers are supplied with calibration certificate at no charge. The additional assurance of a calibration certificate traceable to National Institute of Standard and Technology (NIST), is optionally available at additional cost.

Mikron has an incomparable array of accessories, too numerous to list here. The following is a selection of some of the more commonly used devices.

## Protective Jacket and End Cap

The cast aluminum jacket and end cap protects the "Infraducer" from physical damage when located in environments of heavy industry and also dampens the effect of rapid ambient changes. The precision machining of the protective jacket allows for easy removal and replacement of the "Infraducer" with no loss of alignment. In high ambients when temperature exceeds the maximum rated temperature of the unit, the use of a protective jacket with cooling capability is mandatory. Extensive research and testing of the jacket assures uniform cooling along its entire length and simultaneously isolates the "Infraducer" from thermal influence. While air flow alone is sufficient for light cooling, water must be used for moderate and heavy cooling.

To order specify PN 11609-7 no cooling.  
To order specify PN 11609-8 with cooling.

Ambient Temperature		Gal/Hr.	Liters/Hr.
°F	°C		
150	65	0.2	0.8
200	95	0.6	2.3
250	120	1.0	3.8
300	150	2.0	7.6
350	175	3.0	11.4
400	205	4.0	15.2

## Air Purge and Cooling Assembly

Though simple in outward appearance, this assembly performs very important functions—purging and localized cooling. Air purging of the optics is extremely important when airborne contaminants can build up on the lens and eventually "blind" the optical assembly.

In contrast to many air purge systems currently in use which actually develop a negative pressure vortex and contribute to the build up of contaminants, the Mikron air purge assembly has been carefully engineered by incorporating a unique air director to insure laminar flow, in order to prevent contaminant build-up from occurring. **A flow of only 75 CFH (2CMH) of normally clean industrial air will keep the optics clean under most conditions.**

The metal sight tube is designed for installations where it is desirable to augment the air purge and facilitate approximate aiming of the "Infraducer".

In addition, the cooling plate section of the air purge assembly allows the coolant to circulate in a chamber which allows cooling of "Infraducer" up to ambient temperature of 100°C (210°F). The air purge assembly depends upon the protective jacket for mounting.

To order specify PN 11524-L.

## Aiming Flange Assembly

For installations requiring durable mounting of the "Infraducer" while allowing for adjustment of the optical path to a maximum of 5° in any direction.

To order specify PN 11649-2.

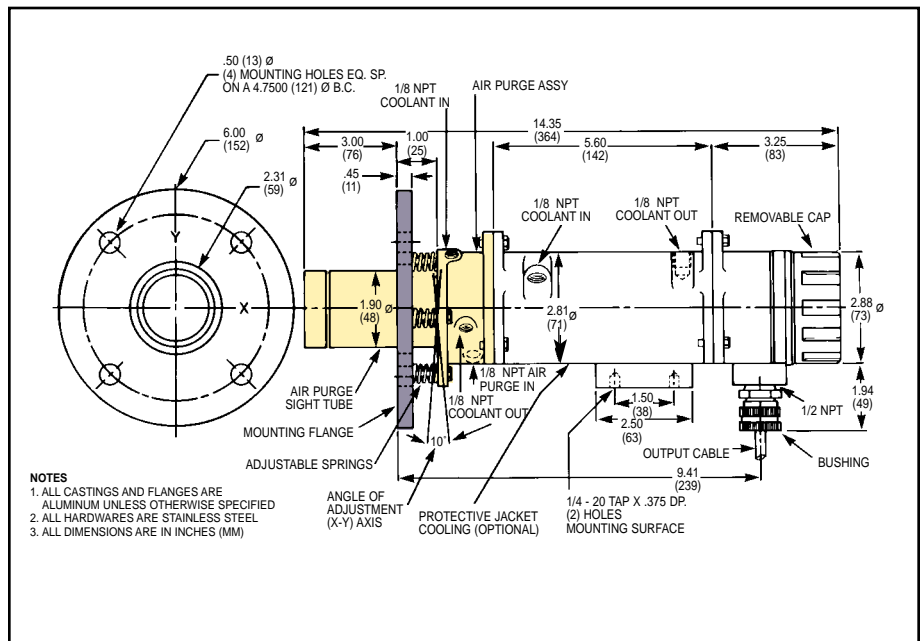
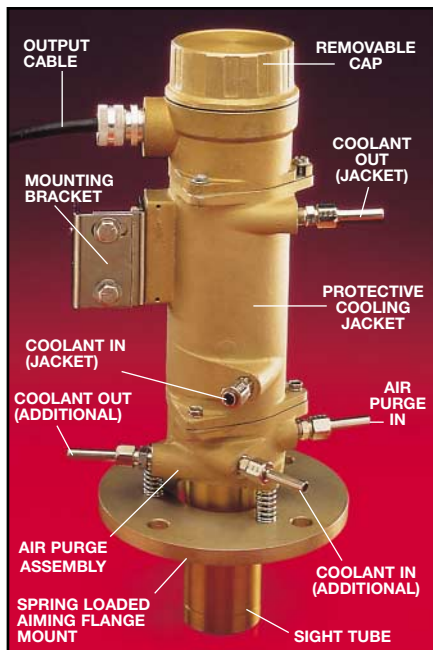



## Removable Window Assembly

Frequently in industrial application the outgassing from process may penetrate the instrument sight tube and deposit on optical assembly, or air supply may be shut off inadvertently resulting in degrading the temperature measurement. The removable

window assembly is exclusively designed to overcome this problem. The window assembly is mounted in front of protective jacket. The maintenance personnel can periodically remove the window by simply pulling it from a slot, cleaning the window if necessary and inserting the window back into the slot. To order specify PN 14925-1.

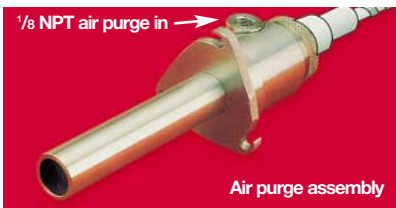

## M780 Air Purge/Cooling Assembly

An air purge is mandatory in most industrial applications to keep the lens assembly clean for

extended periods of time. The air purge is designed to be effective with filtered plant air which does not need to be instrument quality. An air flow of 2.8m<sup>3</sup>/Hr. (100ft<sup>3</sup>/Hr.) is sufficient for most applications. The air purge assembly will also provide cooling if the lens assembly is likely to be exposed to ambient temperatures up to 400°C (750°F). The overall length of this assembly is 168mm (6.6"). The diameter of the air purge sight tube is 19mm (0.75"). To order specify PN 14296-1.

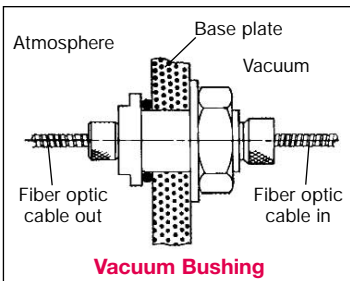

## Fiber Optic Vacuum Bushing

In vacuum applications where sighting through a window is difficult or impossible, a fiber optic cable can be placed inside the vacuum up to 10<sup>-6</sup> torr with the aid of this bushing. The bushing holds a

bundle of fiber optics which is sealed for high vacuum applications. This system seals the vacuum and allows for removal of the cable on either side of the bushing without affecting the integrity of the vacuum seal. To order specify PN 12506.

## Made in U.S.A.

The M770/780 "Infraducers" series are designed and built by Mikron, the leading innovator in infrared technology, manufacturing facility is located in Oakland, New Jersey, USA.

## Warranty

All Model M770/780 "Infraducers" series are covered for all defective material and workmanship for one full year after shipment.

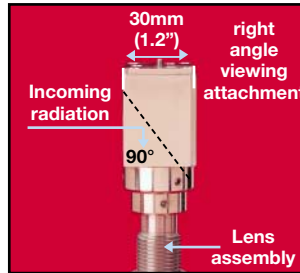

## Right Angle Viewing Attachment

Physical limitations often prohibit conventional mounting of lens assemblies. The right angle viewing attachment provides a means for rotating the physical aspect of the lens assembly by 90° while viewing the desired

target. By using the right angle viewing attachment the lens assembly length of 114mm (4.5") is reduced to 30mm (1.2"). right angle viewing is only available for standard and focusable lens assembly. To order specify PN 16376-2.

## Fiber Optic Target Illuminator



Mikron offers a fiber optic illuminator for precision illumination of the target areas when used in conjunction with fiber optics and lens assembly. This illuminator can conveniently be taken to lens assembly location for precision refocusing or identification of target area.

### AC Line Operation

To order:

Specify PN 12110-1A for 115 VAC

Specify PN 12110-2B for 220 VAC

Specify PN 12110-3C for 100 VAC

## Power Supply



### Power Supply

Power supply for M770/780

"Infraducer" is a low profile, sealed, switching power supply with universal AC input voltage and frequency. Maximum in-rush current of 15A protective power supply when a momentary short circuit occurs. To order specify PN 18712-1.

Input voltage: 90 - 250 VAC

Frequency: 47 to 63Hz

Output Voltage: 24V at 0.7 Amps

Operating Temp: 0° to 50°C (32° to 122°F)

Connection: 5P/9.5mm pitch terminal block

Dimensions: 98mm (H) x 97mm (W) x 35mm (H)  
(3.9" x 3.8" x 1.4")



Mikron Infrared Inc., Headquarters  
16 Thornton Road  
Oakland, NJ 07436 USA  
Tel: 201-405-0900  
Tel: (USA only) 800-631-0176  
Fax: 201-405-0090  
E-mail: sales@mikroninst.com

West Coast Office: Visit our websites: [www.mikroninst.com](http://www.mikroninst.com)  
Mikron [www.IRimaging.com](http://www.IRimaging.com)  
4475 Dupont Court #9  
Ventura, CA 93003  
Tel: 805-644-9544  
Fax: 805-644-9584  
E-mail: sales@e2t.com

M770-780 Rev. 1.3  
Printed in USA  
103102



ISO 9001