

BUMPERS

Female Thread w/ Hex Shoulder | Inch



Used for stops, guides, bumpers and protection. Molded bumper bonded to steel core. Urethane offers highest resistance, strength and load bearing. High elongation hardness. Resistant to ozone and oxygen.

INCH

Part #	A Dia	B Length	C	D	Durometer	Female Thread	Hex	Material
RBH-516-024UR	3/4	13/16	9/16	3/16	80	#10-24x7/16	1/2	Urethane
RBH-516-032UR	3/4	13/16	9/16	3/16	80	#10-32x7/16	1/2	Urethane
RBH-516-120UR	3/4	13/16	9/16	3/16	80	1/4-20x7/16	1/2	Urethane
RBH-516-128UR	3/4	13/16	9/16	3/16	80	1/4-28x7/16	1/2	Urethane
RBH-516-518UR	3/4	13/16	9/16	3/16	80	5/16-18x7/16	1/2	Urethane
RBH-516-524UR	3/4	13/16	9/16	3/16	80	5/16-24x7/16	1/2	Urethane

Female Thread | Small | Inch



Used for stops, guides, bumpers and protection. Molded bumper bonded to steel core. Neoprene offers good resistance against weather, gasoline, oil, ozone and high temperature. Urethane offers highest resistance, strength and load bearing. High elongation hardness and is resistant to ozone and oxygen. Nitrile is chemical resistant and non-marring.

INCH

Part #	A Dia	B Length	C	Durometer	Female Thread	Material
RB-516-024	3/4	5/8	3/8	70	#10-24x1/4	Neoprene
RB-516-032	3/4	5/8	3/8	70	#10-32x1/4	Neoprene
RB-516-120	3/4	5/8	3/8	70	1/4-20x1/4	Neoprene
RB-516-128	3/4	5/8	3/8	70	1/4-28x1/4	Neoprene
RB-516-518	3/4	5/8	3/8	70	5/16-18x1/4	Neoprene
RB-516-524	3/4	5/8	3/8	70	5/16-24x1/4	Neoprene
RB-516-45	3/4	5/8	3/8	45	5/16-18x1/4	Neoprene
RB-516-024UR	3/4	5/8	3/8	80	#10-24x1/4	Urethane
RB-516-032UR	3/4	5/8	3/8	80	#10-32x1/4	Urethane
RB-516-120UR	3/4	5/8	3/8	80	1/4-20x1/4	Urethane
RB-516-128UR	3/4	5/8	3/8	80	1/4-28x1/4	Urethane
RB-516-518UR	3/4	5/8	3/8	80	5/16-18x1/4	Urethane
RB-516-524UR	3/4	5/8	3/8	80	5/16-24x1/4	Urethane
RB-516-60UR	3/4	5/8	3/8	60	5/16-18x1/4	Urethane
RB-516-70W	3/4	5/8	3/8	70	5/16-18x1/4	White Nitrile

BUMPERS

Female Thread | Large | Inch

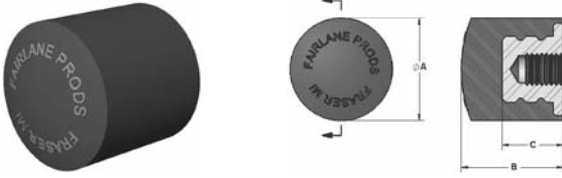

Used for stops, guides, bumpers and protection. Molded bumper bonded to steel core. Neoprene offers good resistance against weather, gasoline, oil, ozone and high temperature. Urethane offers highest resistance, strength and load bearing. High elongation hardness and is resistant to ozone and oxygen. Nitrile is chemical resistant and non-marring.

INCH

Part #	A Dia	B Length	C	Durometer	Female Thread	Material
RB-3	1-1/4	1-1/4	3/4	40	3/8-16x1/2	Neoprene
RB-4	1-1/4	1-1/4	3/4	40	3/8-24x1/2	Neoprene
RB-5	1-1/4	1-1/4	3/4	40	1/2-13x1/2	Neoprene
RB-6	1-1/4	1-1/4	3/4	40	1/2-20x1/2	Neoprene
RB-7	1-1/4	1-1/4	3/4	40	7/16-20x1/2	Neoprene
RB-8	1-1/4	1-1/4	3/4	40	5/8-18x1/2	Neoprene
RB-9	1-3/4	1-5/8	7/8	40	5/8-11x5/8	Neoprene
RB-10	1-3/4	1-5/8	7/8	40	5/8-18x5/8	Neoprene
RB-12	2-1/4	2-1/4	1-3/8	40	3/4-10x1	Neoprene
RB-13	2-1/4	2-1/4	1-3/8	40	3/4-16x1	Neoprene
RB-14	2-1/4	2-1/4	1-3/8	40	1-8x1	Neoprene
RB-3W	1-1/4	1-1/4	3/4	40	3/8-16x1/2	White Nitrile
RB-4W	1-1/4	1-1/4	3/4	40	3/8-24x1/2	White Nitrile
RB-5W	1-1/4	1-1/4	3/4	40	1/2-13x1/2	White Nitrile
RB-6W	1-1/4	1-1/4	3/4	40	1/2-20x1/2	White Nitrile
RB-7W	1-1/4	1-1/4	3/4	40	7/16-20x1/2	White Nitrile
RB-8W	1-1/4	1-1/4	3/4	40	5/8-18x1/2	White Nitrile
RB-9W	1-3/4	1-5/8	7/8	40	5/8-11x5/8	White Nitrile
RB-10W	1-3/4	1-5/8	7/8	40	5/8-18x5/8	White Nitrile
RB-12W	2-1/4	2-1/4	1-3/8	40	3/4-10x1	White Nitrile
RB-13W	2-1/4	2-1/4	1-3/8	40	3/4-16x1	White Nitrile
RB-14W	2-1/4	2-1/4	1-3/8	40	1-8x1	White Nitrile
RB-3-60UR	1-1/4	1-1/4	3/4	60	3/8-16x1/2	Urethane
RB-3UR	1-1/4	1-1/4	3/4	80	3/8-16x1/2	Urethane
RB-4-60UR	1-1/4	1-1/4	3/4	60	3/8-24x1/2	Urethane
RB-4UR	1-1/4	1-1/4	3/4	80	3/8-24x1/2	Urethane
RB-5-60UR	1-1/4	1-1/4	3/4	60	1/2-13x1/2	Urethane
RB-5UR	1-1/4	1-1/4	3/4	80	1/2-13x1/2	Urethane
RB-6-60UR	1-1/4	1-1/4	3/4	60	1/2-20x1/2	Urethane
RB-6UR	1-1/4	1-1/4	3/4	80	1/2-20x1/2	Urethane
RB-7-60UR	1-1/4	1-1/4	3/4	60	7/16-20x1/2	Urethane
RB-7UR	1-1/4	1-1/4	3/4	80	7/16-20x1/2	Urethane
RB-8-60UR	1-1/4	1-1/4	3/4	60	5/8-18x1/2	Urethane
RB-8UR	1-1/4	1-1/4	3/4	80	5/8-18x1/2	Urethane
RB-9-60UR	1-3/4	1-5/8	7/8	60	5/8-11x5/8	Urethane
RB-9UR	1-3/4	1-5/8	7/8	80	5/8-11x5/8	Urethane
RB-10-60UR	1-3/4	1-5/8	7/8	60	5/8-18x5/8	Urethane
RB-10UR	1-3/4	1-5/8	7/8	80	5/8-18x5/8	Urethane
RB-12-60UR	2-1/4	2-1/4	1-3/8	60	3/4-10x1	Urethane
RB-12UR	2-1/4	2-1/4	1-3/8	80	3/4-10x1	Urethane
RB-13-60UR	2-1/4	2-1/4	1-3/8	60	3/4-16x1	Urethane
RB-13UR	2-1/4	2-1/4	1-3/8	80	3/4-16x1	Urethane
RB-14-60UR	2-1/4	2-1/4	1-3/8	60	1-8x1	Urethane
RB-14UR	2-1/4	2-1/4	1-3/8	80	1-8x1	Urethane

BUMPERS

Female Thread | Metric

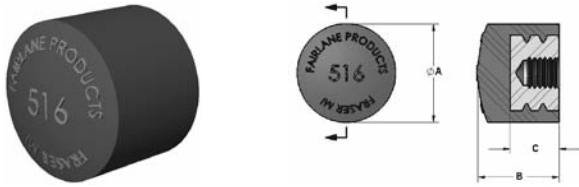

Used for stops, guides, bumpers and protection. Molded bumper bonded to steel core. Neoprene offers good resistance against weather, gasoline, oil, ozone and high temperature. Urethane offers highest resistance, strength and load bearing. High elongation hardness. Resistant to ozone and oxygen.

METRIC

Part #	A Dia	B Length	C	Durometer	Female Thread	Thread Depth	Material
MRB-5166	19	16	9.0	70	M6X1.0	6	Neoprene
MRB-5168	19	16	9.0	70	M8X1.25	6	Neoprene
MRB-3	32	32	19.0	40	M10X1.5	13	Neoprene
MRB-4	32	32	19.0	40	M10X1.25	13	Neoprene
MRB-5	32	32	19.0	40	M12X1.75	13	Neoprene
MRB-6	32	32	19.0	40	M12X1.25	13	Neoprene
MRB-8	32	32	19.0	40	M16X2.0	13	Neoprene
MRB-9	45	42	22.5	40	M16X2.0	16	Neoprene
MRB-12	57	57	35.0	40	M20X2.5	25	Neoprene
MRB-14	57	57	35.0	40	M24X3.0	25	Neoprene
MRB-5166-80UR	19	16	9.0	80	M6X1.0	6	Urethane
MRB-5168-80UR	19	16	9.0	80	M8X1.25	6	Urethane
MRB-3UR	32	32	19.0	80	M10X1.5	13	Urethane
MRB-4UR	32	32	19.0	80	M10X1.25	13	Urethane
MRB-5UR	32	32	19.0	80	M12X1.75	13	Urethane
MRB-6UR	32	32	19.0	80	M12X1.25	13	Urethane
MRB-8UR	32	32	19.0	80	M16X2.0	13	Urethane
MRB-9UR	45	42	22.5	80	M16X2.0	16	Urethane
MRB-12UR	57	57	35.0	80	M20X2.5	25	Urethane
MRB-14UR	57	57	35.0	80	M24X3.0	25	Urethane

BUMPERS

Male Thread | Inch

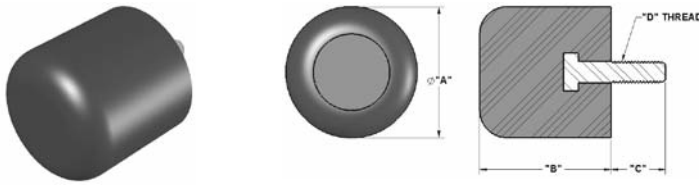

Used for stops, guides, bumpers and protection. Molded bumper bonded to steel core. Urethane offers highest resistance, strength and load bearing. High elongation hardness and is resistant to ozone and oxygen.

INCH							
Part #	A Dia	B Length	C	D Thread	R	Durometer	Material
RB-1010-M14-60UR	1	1	7/8	5/16-18	1/4	60	Urethane
RB-1010-M14-80UR	1	1	7/8	5/16-18	1/4	80	Urethane
RB-1515-M14-60UR	1-1/2	1-1/2	7/8	5/16-18	5/16	60	Urethane
RB-1515-M14-80UR	1-1/2	1-1/2	7/8	5/16-18	5/16	80	Urethane
RB-2020-M14-60UR	2	2	7/8	5/16-18	3/8	60	Urethane
RB-2020-M14-80UR	2	2	7/8	5/16-18	3/8	80	Urethane
RB-2525-M14-60UR	2-1/2	2-1/2	7/8	3/8-16	1/2	60	Urethane
RB-2525-M14-80UR	2-1/2	2-1/2	7/8	3/8-16	1/2	80	Urethane
RB-3030-M20-60UR	3	3	1-1/4	1/2-13	5/8	60	Urethane
RB-3030-M20-80UR	3	3	1-1/4	1/2-13	5/8	80	Urethane
RB-4040-M21-60UR	4	4	1-5/16	1/2-13	3/4	60	Urethane
RB-4040-M21-80UR	4	4	1-5/16	1/2-13	3/4	80	Urethane

Male Thread | Radius Top | Inch



Used for stops, guides, bumpers and protection. Molded bumper bonded to steel core. Neoprene offers good resistance against weather, gasoline, oil, ozone and high temperature. Urethane offers highest resistance, strength and load bearing. High elongation hardness and is resistant to ozone and oxygen.

INCH					
Part #	A Dia	B Length	Durometer	Male Thread	Material
RB-15M-12	1-1/2	13/16	40	3/8-16x3/4	Neoprene
RB-15URM-12	1-1/2	13/16	80	3/8-16x3/4	Urethane

Male Thread | Flat Top | Inch

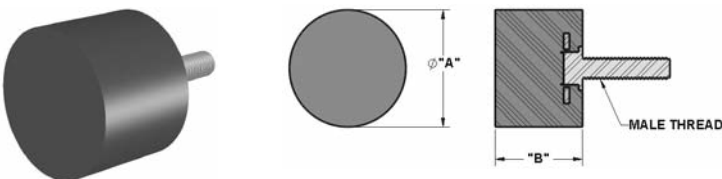

Used for stops, guides, bumpers and protection. Molded bumper bonded to steel core. Neoprene offers good resistance against weather, gasoline, oil, ozone and high temperature.

INCH					
Part #	A Dia	B Length	Durometer	Male Thread	Material
RB-2015M-8	2	1-1/2	60	3/8-16x1/2	Neoprene
RB-2015M-24	2	1-1/2	60	3/8-16x1-1/2	Neoprene

BUMPERS

Male Thread with Hex Shoulder | Inch



Used for stops, guides, bumpers and protection. Molded bumper bonded to steel core. Neoprene offers good resistance against weather, gasoline, oil, ozone and high temperature. Urethane offers highest resistance, strength and load bearing. High elongation hardness and is resistant to ozone and oxygen. Nitrile is chemical resistant and non-marring.

INCH

Part #	A Dia	B Length	C	Durometer	Hex	Male Thread	Material
RB-516-024M-8	3/4	5/8	3/8	70	1/2	#10-24x1/2	Neoprene
RB-516-024M-20	3/4	5/8	3/8	70	1/2	#10-24x1-1/4	Neoprene
RB-516-032M-8	3/4	5/8	3/8	70	1/2	#10-32x1/2	Neoprene
RB-516-032M-20	3/4	5/8	3/8	70	1/2	#10-32x1-1/4	Neoprene
RB-516-120M-8	3/4	5/8	3/8	70	1/2	1/4-20x1/2	Neoprene
RB-516-120M-20	3/4	5/8	3/8	70	1/2	1/4-20x1-1/4	Neoprene
RB-516-128M-8	3/4	5/8	3/8	70	1/2	1/4-28x1/2	Neoprene
RB-516-128M-20	3/4	5/8	3/8	70	1/2	1/4-28x1-1/4	Neoprene
RB-516-524M-8	3/4	5/8	3/8	70	1/2	5/16-24x1/2	Neoprene
RB-516-524M-20	3/4	5/8	3/8	70	1/2	5/16-24x1-1/4	Neoprene
RB-516-M-8	3/4	5/8	3/8	70	1/2	5/16-18x1/2	Neoprene
RB-516-M-20	3/4	5/8	3/8	70	1/2	5/16-18x1-1/4	Neoprene
RB-516-024URM-8	3/4	5/8	3/8	80	1/2	#10-24x1/2	Urethane
RB-516-024URM-20	3/4	5/8	3/8	80	1/2	#10-24x1-1/4	Urethane
RB-516-032URM-8	3/4	5/8	3/8	80	1/2	#10-32x1/2	Urethane
RB-516-032URM-20	3/4	5/8	3/8	80	1/2	#10-32x1-1/4	Urethane
RB-516-120URM-8	3/4	5/8	3/8	80	1/2	1/4-20x1/2	Urethane
RB-516-120URM-20	3/4	5/8	3/8	80	1/2	1/4-20x1-1/4	Urethane
RB-516-128URM-8	3/4	5/8	3/8	80	1/2	1/4-28x1/2	Urethane
RB-516-128URM-20	3/4	5/8	3/8	80	1/2	1/4-28x1-1/4	Urethane
RB-516-524URM-8	3/4	5/8	3/8	80	1/2	5/16-24x1/2	Urethane
RB-516-524URM-20	3/4	5/8	3/8	80	1/2	5/16-24x1-1/4	Urethane
RB-516-URM-8	3/4	5/8	3/8	80	1/2	5/16-18x1/2	Urethane
RB-516-URM-20	3/4	5/8	3/8	80	1/2	5/16-18x1-1/4	Urethane
RB-516-WM-8	3/4	5/8	3/8	70	1/2	5/16-18x1/2	White Nitrile
RB-516-WM-20	3/4	5/8	3/8	70	1/2	5/16-18x1-1/4	White Nitrile

Male Thread with Hex Shoulder | Metric



Used for stops, guides, bumpers and protection. Molded bumper bonded to steel core with hex shoulder. Neoprene offers good resistance against weather, gasoline, oil, ozone and high temperature. Urethane offers highest resistance, strength and load bearing. High elongation hardness. Resistant to ozone and oxygen.

METRIC

Part #	A Dia	B Length	C	D Hex Standoff	Durometer	Stud Thread	Stud Length	Material
MRB-5166X15	19	16	9	3.2	70	M6X1.0	15	Neoprene
MRB-5166X30	19	16	9	3.2	70	M6X1.0	30	Neoprene
MRB-5168X15	19	16	9	4.0	70	M8X1.25	15	Neoprene
MRB-5168X30	19	16	9	4.0	70	M8X1.25	30	Neoprene
MRB-5166URX15	19	16	9	3.2	80	M6X1.0	15	Urethane
MRB-5166URX30	19	16	9	3.2	80	M6X1.0	30	Urethane
MRB-5168URX15	19	16	9	4.0	80	M8X1.25	15	Urethane
MRB-5168URX30	19	16	9	4.0	80	M8X1.25	30	Urethane

BUMPERS

Male Thread | Inch

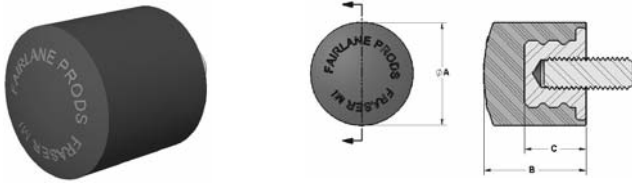

Used for stops, guides, bumpers and protection. Molded bumper bonded to steel core. Neoprene offers good resistance against weather, gasoline, oil, ozone and high temperature. Urethane offers highest resistance, strength and load bearing. High elongation hardness and is resistant to ozone and oxygen. Nitrile is chemical resistant and non-marring.

INCH

Part #	A Dia	B Length	C	Durometer	Male Thread	Material
RB-3M-10	1-1/4	1-1/4	3/4	40	3/8-16x5/8	Neoprene
RB-3M-16	1-1/4	1-1/4	3/4	40	3/8-16x1	Neoprene
RB-3M-20	1-1/4	1-1/4	3/4	40	3/8-16x1-1/4	Neoprene
RB-8M-16	1-1/4	1-1/4	3/4	40	5/8-18x1	Neoprene
RB-14M-13	1-1/4	1-1/4	3/4	40	1/2-13x3/4	Neoprene
RB-3WM-10	1-1/4	1-1/4	3/4	40	3/8-16x5/8	White Nitrile
RB-3WM-16	1-1/4	1-1/4	3/4	40	3/8-16x1	White Nitrile
RB-3WM-20	1-1/4	1-1/4	3/4	40	3/8-16x1-1/4	White Nitrile
RB-8WM-16	1-1/4	1-1/4	3/4	40	5/8-18x1	White Nitrile
RB-14WM-13	1-1/4	1-1/4	3/4	40	1/2-13x3/4	White Nitrile
RB-3URM-10	1-1/4	1-1/4	3/4	80	3/8-16x5/8	Urethane
RB-3URM-16	1-1/4	1-1/4	3/4	80	3/8-16x1	Urethane
RB-3URM-20	1-1/4	1-1/4	3/4	80	3/8-16x1-1/4	Urethane
RB-8URM-16	1-1/4	1-1/4	3/4	80	5/8-18x1	Urethane
RB-14URM-13	1-1/4	1-1/4	3/4	80	1/2-13x3/4	Urethane

Male Thread | Metric

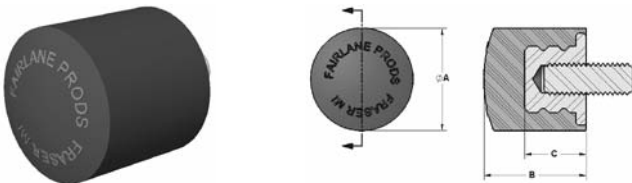

Used for stops, guides, bumpers and protection. Molded bumper bonded to steel core. Neoprene offers good resistance against weather, gasoline, oil, ozone and high temperature. Urethane offers highest resistance, strength and load bearing. High elongation hardness. Resistant to ozone and oxygen.

METRIC

Part #	A Dia	B Length	C	Durometer	Stud Thread	Stud Length	Material
MRB-3X15	32	32	19.0	40	M10X1.5	15	Neoprene
MRB-3X30	32	32	19.0	40	M10X1.5	30	Neoprene
MRB-5X15	32	32	19.0	40	M12X1.75	15	Neoprene
MRB-5X30	32	32	19.0	40	M12X1.75	30	Neoprene
MRB-8X15	32	32	19.0	40	M16X2.0	15	Neoprene
MRB-8X30	32	32	19.0	40	M16X2.0	30	Neoprene
MRB-9X15	45	42	22.5	40	M16X2.0	15	Neoprene
MRB-9X30	45	42	22.5	40	M16X2.0	30	Neoprene
MRB-3URX15	32	32	19.0	80	M10X1.5	15	Urethane
MRB-3URX30	32	32	19.0	80	M10X1.5	30	Urethane
MRB-5URX15	32	32	19.0	80	M12X1.75	15	Urethane
MRB-5URX30	32	32	19.0	80	M12X1.75	30	Urethane
MRB-8URX15	32	32	19.0	80	M16X2.0	15	Urethane
MRB-8URX30	32	32	19.0	80	M16X2.0	30	Urethane
MRB-9URX15	45	42	22.5	80	M16X2.0	15	Urethane
MRB-9URX30	45	42	22.5	80	M16X2.0	30	Urethane

BUMPERS

Rectangle and Square Bumpers With Steel Plate

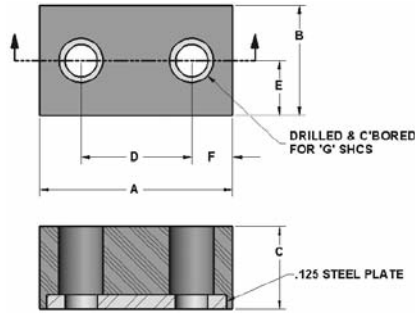
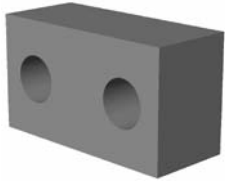

Used for stops, guides, bumpers and protection. Molded bumper bonded to steel plate. Neoprene offers good resistance against weather, gasoline, oil, ozone and high temperature. The Urethane offers highest resistance, strength and load bearing. High elongation hardness. Resistant to ozone and oxygen.

INCH

Part#	A	B	C	D	E	F	G For SHCS	Durometer	Number of Holes	Material
RB-7575	3/4	3/4	5/8	-	3/8	3/8	1/4 (6mm)	80	1	Neoprene
RB-7525	2-1/2	5/8	5/8	1-1/2	5/16	1/2	1/4 (6mm)	80	2	Neoprene
RB-1175	1-3/4	1	3/4	1	1/2	3/8	1/4 (6mm)	80	2	Neoprene
RB-1175-35	1-3/4	1	3/4	1	1/2	3/8	1/4 (6mm)	35	2	Neoprene
RB-2025-C	2-1/2	2	2	1-1/2	1	1/2	5/16	80	2	Neoprene
RB-2025	2-1/2	2	2	-	-	-	-	80	-	Neoprene
RB-7575-UR	3/4	3/4	5/8	-	3/8	3/8	1/4 (6mm)	80	1	Urethane
RB-7525-UR	2-1/2	5/8	5/8	1-1/2	5/16	1/2	1/4 (6mm)	80	2	Urethane
RB-1137-UR	1-3/4	1	3/8	1	1/2	3/8	1/4 (6mm)	80	2	Urethane
RB-1150-UR	1-3/4	1	1/2	1	1/2	3/8	1/4 (6mm)	80	2	Urethane
RB-1175-UR	1-3/4	1	3/4	1	1/2	3/8	1/4 (6mm)	80	2	Urethane
RB-2025-C-UR	2-1/2	2	2	1-1/2	1	1/2	5/16	80	2	Urethane
RB-2025-UR	2-1/2	2	2	-	-	-	-	80	-	Urethane
RB-7575-60UR	3/4	3/4	5/8	-	3/8	3/8	1/4 (6mm)	60	1	Urethane
RB-7525-60UR	2-1/2	5/8	5/8	1-1/2	5/16	1/2	1/4 (6mm)	60	2	Urethane
RB-1137-60UR	1-3/4	1	3/8	1	1/2	3/8	1/4 (6mm)	60	2	Urethane
RB-1150-60UR	1-3/4	1	1/2	1	1/2	3/8	1/4 (6mm)	60	2	Urethane
RB-1175-60UR	1-3/4	1	3/4	1	1/2	3/8	1/4 (6mm)	60	2	Urethane

Rectangle Bumpers With Aluminum Plate

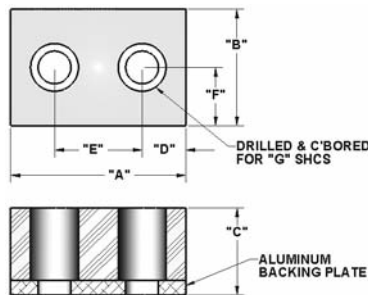
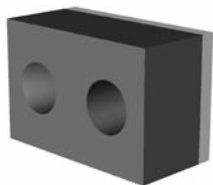

Used for stops, guides, bumpers and protection. Molded bumper bonded to 1/8" aluminum plate. Neoprene offers good resistance against weather, gasoline, oil, ozone and high temperature.

INCH

Part#	A	B	C	D	Durometer	E	F	G	Material	Number of Holes
RB-241612-142	1 1/2	1	3/4	3/8	80	3/4	1/2	1/4	Neoprene	2
RB-281628-142	1 3/4	1	1 3/4	3/8	80	1	1/2	1/4	Neoprene	2
RB-481628-382	3	1	1 3/4	5/8	80	1 3/4	1/2	3/8	Neoprene	2
RB-482416-5162	3	1 1/2	1	1/2	80	2	3/4	5/16	Neoprene	2
RB-641612-142	4	1	3/4	1 1/2	80	1	1/2	1/4	Neoprene	2

BUMPERS

Bonded to Steel Plate

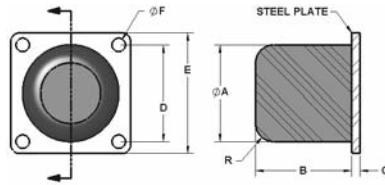
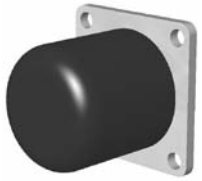

Used for stops, guides, bumpers and protection. Molded urethane bonded to steel plate. Urethane offers highest resistance, strength and load bearing. High elongation hardness. Resistant to ozone and oxygen.

INCH									
Part #	A Dia	B Length	C	D	Durometer	E	F	R	Material
RB-2020-P-60UR	2	2	3/16	2	60	2-1/2	9/32	3/8	Urethane
RB-2525-P-60UR	2-1/2	2-1/2	3/16	2-1/2	60	3-1/4	9/32	1/2	Urethane
RB-3030-P-60UR	3	3	1/4	3	60	4	13/32	5/8	Urethane
RB-4040-P-60UR	4	4	1/4	4	60	5	13/32	3/4	Urethane
RB-2020-P-80UR	2	2	3/16	2	80	2-1/2	9/32	3/8	Urethane
RB-2525-P-80UR	2-1/2	2-1/2	3/16	2-1/2	80	3-1/4	9/32	1/2	Urethane
RB-3030-P-80UR	3	3	1/4	3	80	4	13/32	5/8	Urethane
RB-4040-P-80UR	4	4	1/4	4	80	5	13/32	3/4	Urethane

Rectangle and Square Bumpers Without Plate

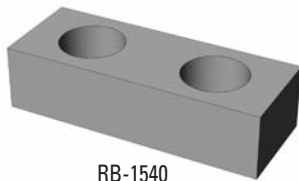

RB-1540

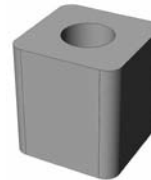
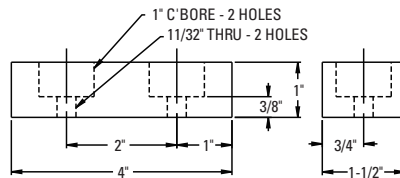

RB-2020-C

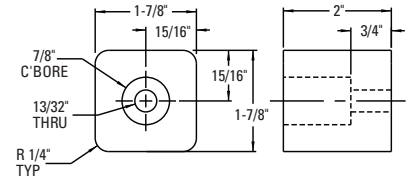

Used for stops, guides, bumpers and protection. They do not have a plate backing so there is no metal to rust or corrode. Neoprene offers good resistance against weather, gasoline, ozone and temperature.

Part #	Material	Durometer
RB-1540	Neoprene	60
RB-2020-C	Neoprene	80

Rectangle Bumpers With Plate / Backside Mounting

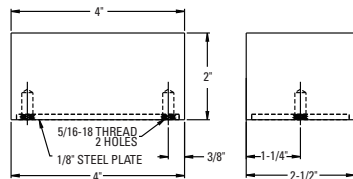

Used for stops, guides, bumpers and protection. 1/8" steel plate has two holes for backside mounting. Neoprene offers good resistance against weather, gasoline, ozone and temperature.

Part #	Material	Durometer
RB-2540-T	Neoprene	80